

JVCKENWOOD

KAS-20 - "Sneak Preview"

KAS-20 – AVL & Dispatch Messaging Software

- ◆ KAS-20 is JVCENWOOD'S new and improved AVL & Dispatch Messaging Software. This new software can be installed and configured on a single computer as a stand-alone program or in a server environment, allowing for greater multi user connectivity and management to the application. Up to 10 computers can be connected when installed and configured on a server. This is a feature that was not available with the KAS-10.
- ◆ This presentation will give you a brief overview of the KAS-20 key features

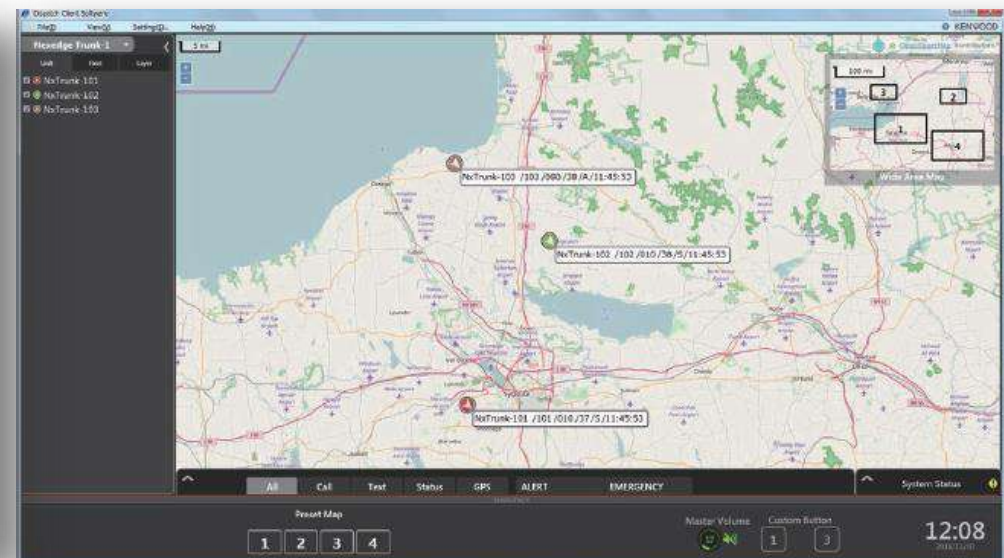

KAS-20 – AVL & Dispatch Messaging Software

- ◆ General Key Features
- ◆ AVL Key Features
- ◆ Dispatch Key Feature
- ◆ Licensing

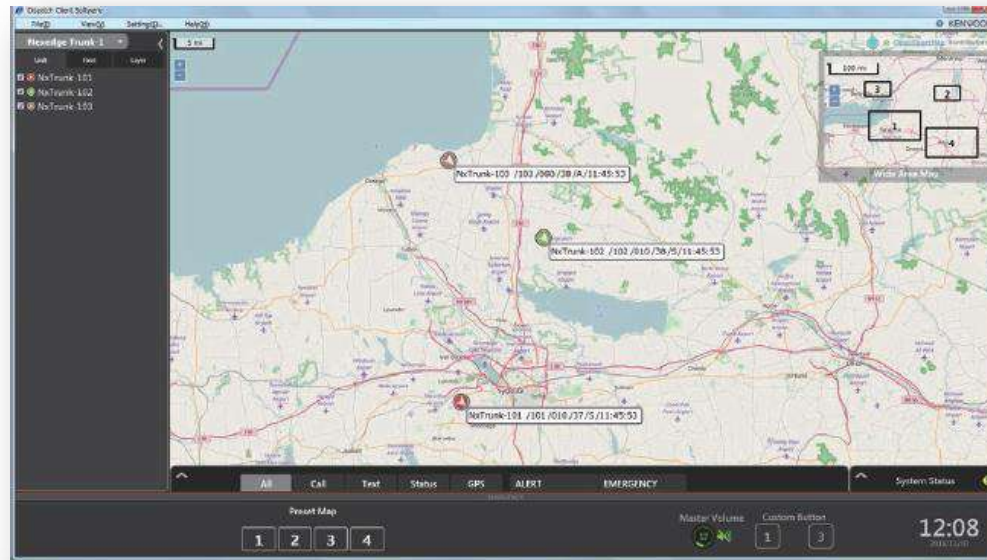

KAS-20 – General Key Features

◆ General Key Features

- ❑ Stand-alone installation or Server Installation
- ❑ Multiple protocols
- ❑ Multiple Networks
- ❑ Multiple Clients
- ❑ Multiple Users
- ❑ Event Logging
- ❑ OAA Support

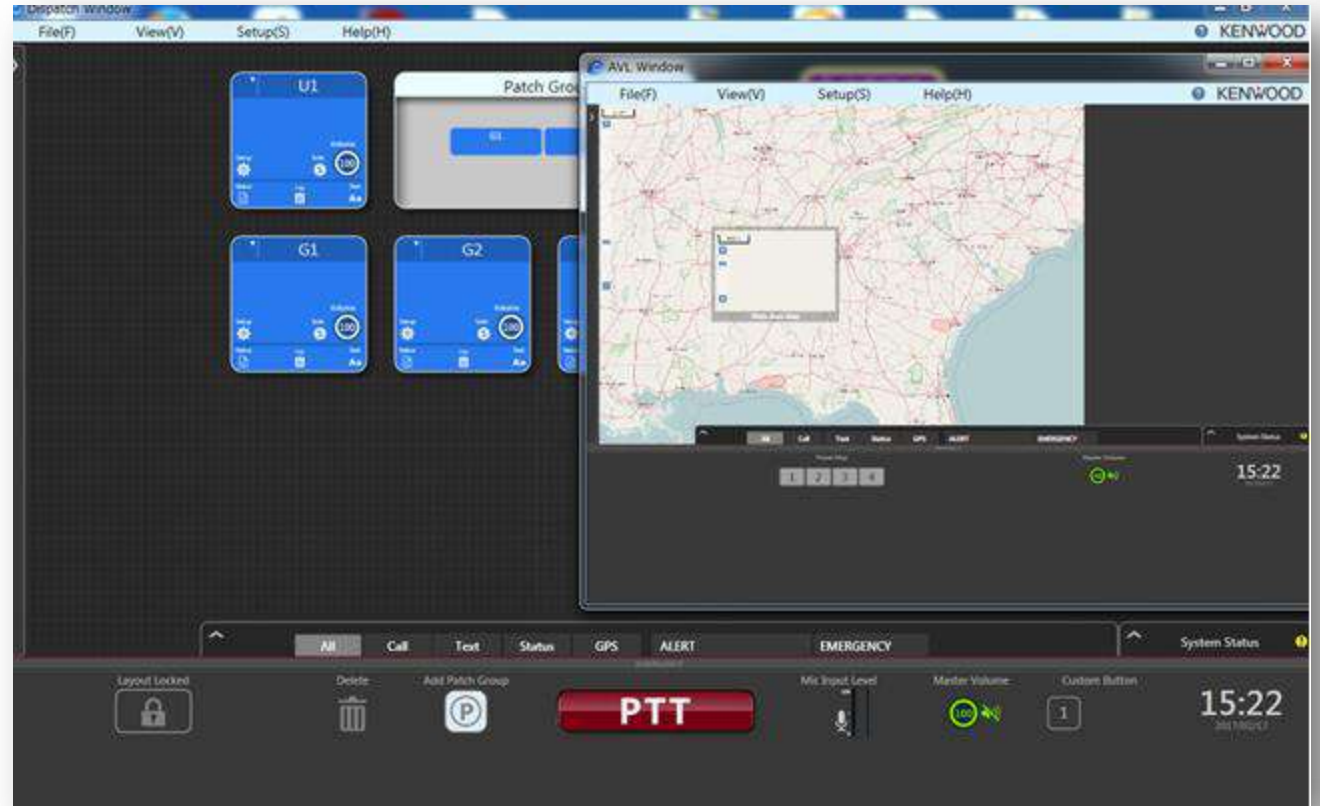

KAS-20 – General Key Features

◆ Stand-alone installation or Server Installation

▣ The KAS-20 has two main installation files;

- KAS-20S – Server base software installation file
- KAS-20C – Client base installation software file
- **Note.** An SQL (Structured Query Language) relational databased management file/software will be needed for both stand-alone installation and server installation. This is not provided by JVCKENWOOD.

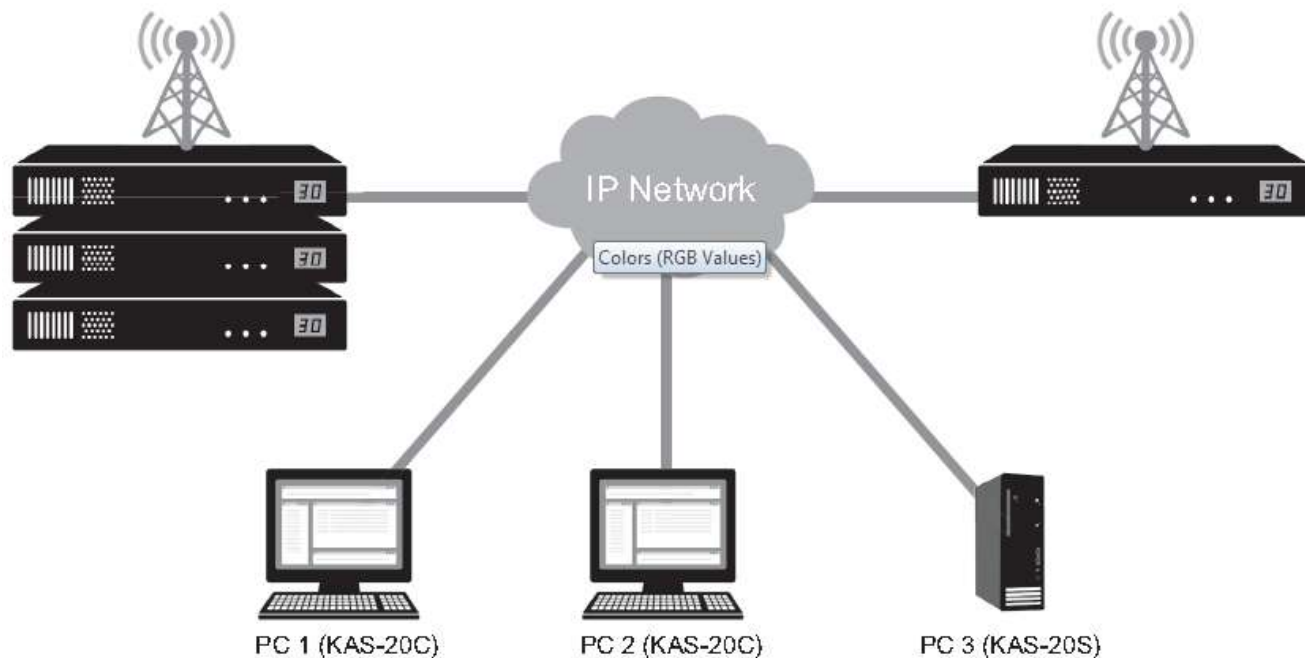

KAS-20 – General Key Features

◆ Multiple Protocols

- ▣ The KAS-20 will give the user the ability manage multiple protocols. This initial version of the software will allow you to handle three

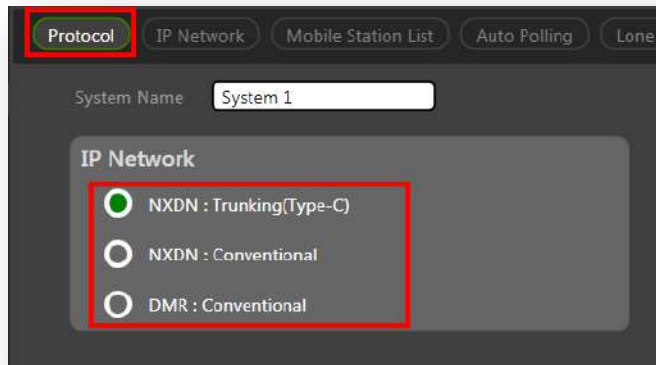

◆ Multiple Networks

- ▣ Up to 8 different Networks/ Systems can be configure in the KAS-20. This means a user can configure the KAS-20 to manage and track users on a DMR System, NXDN Conventional System and NXDN Type C trunking system.

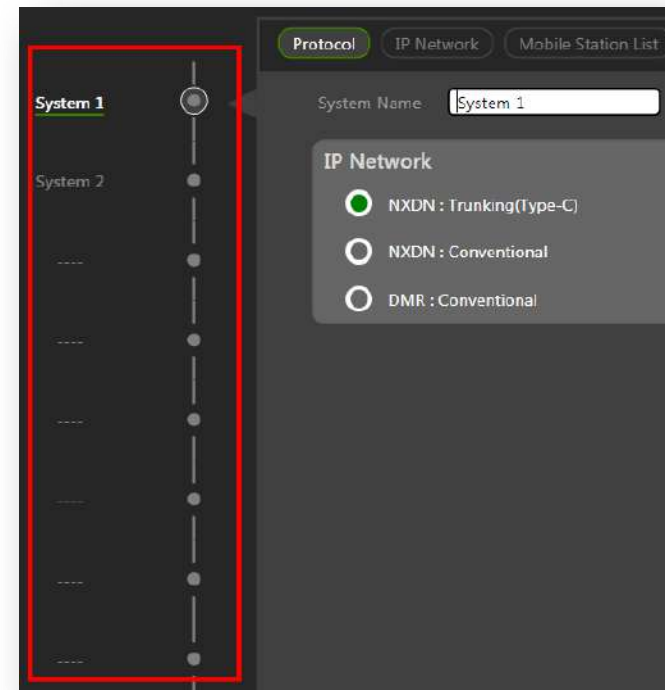

KAS-20 – General Key Features

◆ Multiple Clients / Computers

- When configured in a server environment, up to 10 clients / computers can be connected. This gives the user the flexibility of multiple computers dispatching and managing the units in the field at the same time

◆ Multiple Users

- Up to 20 users can be configured for each computer connected to the server. Each user can be configured with different levels of access and password in the KAS-20.

Access Level	Scope of Authority
Admin	Authorized to perform all types of operation and setting. These include operation on the AVL Window and Dispatch Window as well as changing of settings on the setting screen.
Basic	Operation is possible on the AVL Window and Dispatch Window. However, creating of a Patch and sending of special commands are not allowed.
Basic + Patch	Authorized to create a Patch in addition to the Basic operation authority.
Basic + Special	Authorized to send special commands in addition to the Basic operation authority.
Basic + Patch&Special	Authorized to create a Patch and send special commands in addition to the Basic operation authority.

KAS-20 – General Key Features

◆ Event Logging

- Similar to the Activity window in the KAS-10, the KAS-20 has an Event Log screen that keeps track of all the activities in and out of the KAS-20

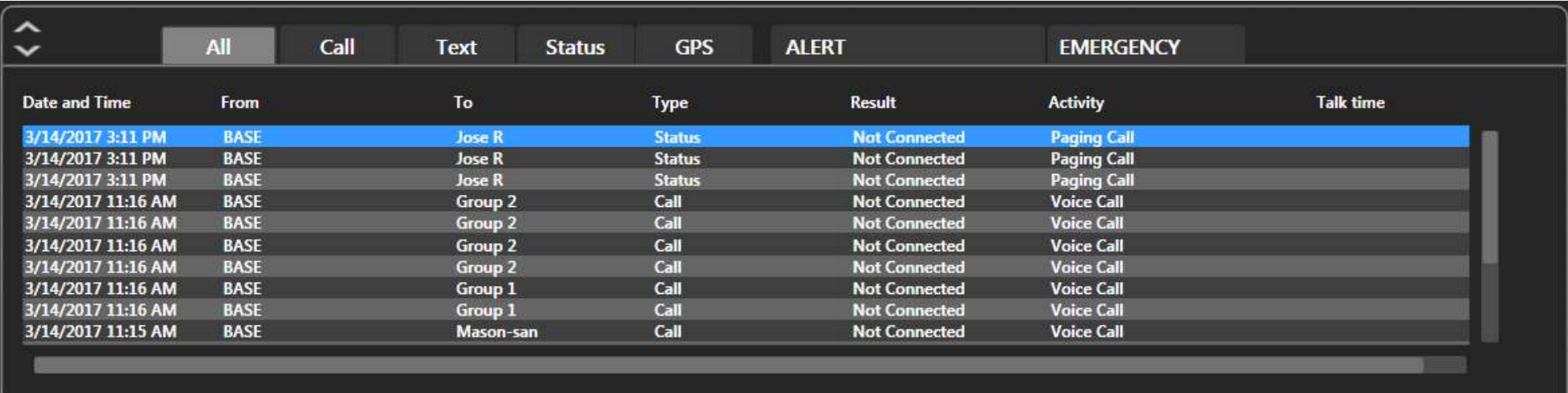

Date and Time	From	To	Type	Result	Activity	Talk time
3/14/2017 3:11 PM	BASE	Jose R	Status	Not Connected	Paging Call	
3/14/2017 3:11 PM	BASE	Jose R	Status	Not Connected	Paging Call	
3/14/2017 3:11 PM	BASE	Jose R	Status	Not Connected	Paging Call	
3/14/2017 11:16 AM	BASE	Group 2	Call	Not Connected	Voice Call	
3/14/2017 11:16 AM	BASE	Group 2	Call	Not Connected	Voice Call	
3/14/2017 11:16 AM	BASE	Group 2	Call	Not Connected	Voice Call	
3/14/2017 11:16 AM	BASE	Group 2	Call	Not Connected	Voice Call	
3/14/2017 11:16 AM	BASE	Group 1	Call	Not Connected	Voice Call	
3/14/2017 11:16 AM	BASE	Group 1	Call	Not Connected	Voice Call	
3/14/2017 11:15 AM	BASE	Mason-san	Call	Not Connected	Voice Call	

◆ OAA Support

- Over the Air Alias is now supported by the new KAS-20. This means that if a caller is not part of the mobile list configured in the KAS-20, the user will still be able to see and identify the caller's alias in the activity / event window above.

KAS-20 – AVL Key Features

◆ AVL Key Features

- ❑ Open Street Map
- ❑ Scanned Map
- ❑ Geofence
- ❑ Polling and Lone Worker by Console
- ❑ Fleet Base Display
- ❑ Emergency Alerts
- ❑ GEN2 GPS

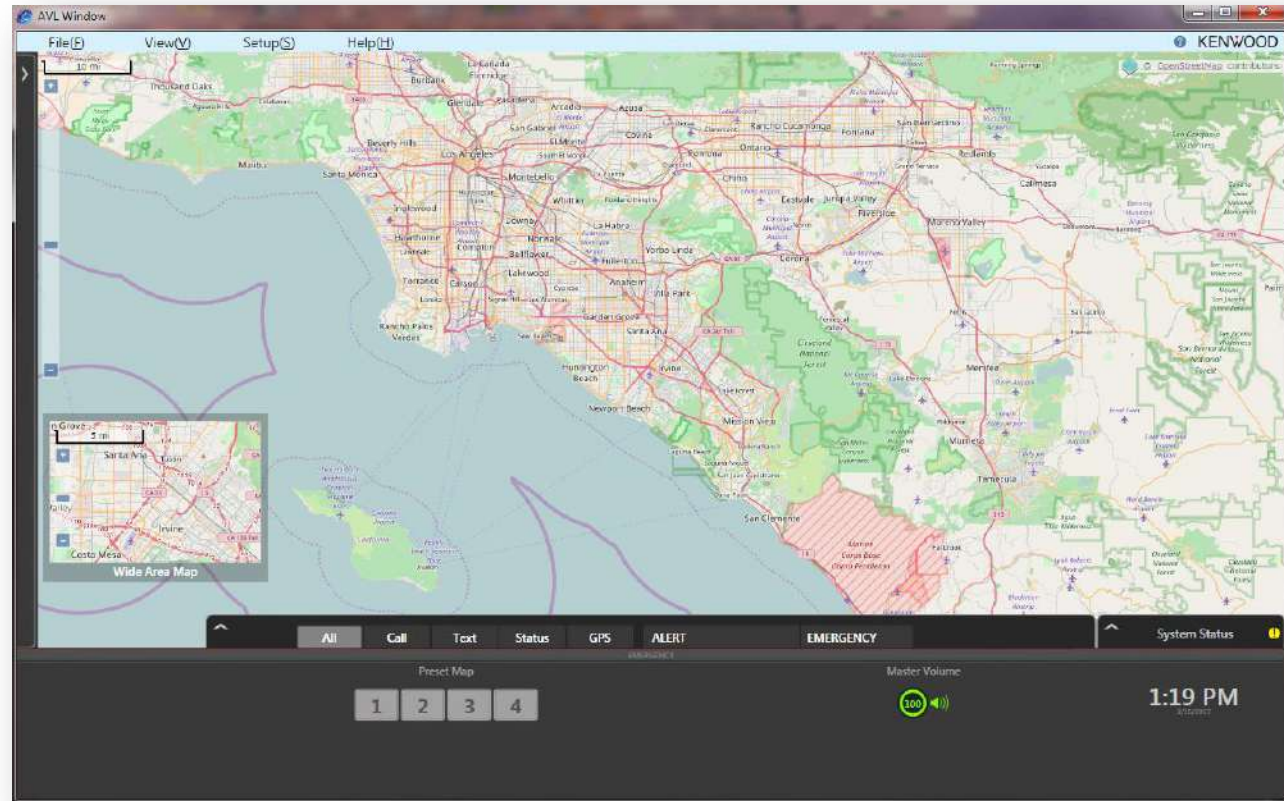

KAS-20 – AVL Key Features

◆ Open Street Map

- ▣ The KAS-20 is now compatible with “Open Street Map” Software. Once you have entered a link to Open Street Map and save it, the software will display the map. The user can now configure the map according to their needs.

The screenshot displays the AVL Window software interface. The main window shows a map of San Diego with various city names and landmarks. A 'Wide Area Map' inset is visible in the bottom-left corner. The top menu bar includes 'File(F)', 'View(V)', 'Setup(S)', and 'Help(H)'. The bottom status bar shows 'All', 'Call', 'Text', 'Status', 'GPS', 'ALERT', 'EMERGENCY', and 'System Status'. A 'Preset Map' section at the bottom has buttons for '1', '2', '3', and '4'. The 'Master Volume' is set to 100%. The time is 1:19 PM.

Overlaid on the map is a 'Map Settings' dialog box. It contains two radio buttons: 'OpenStreetMap' (checked) and 'Scanned Map' (unchecked). To the right of the 'OpenStreetMap' option is a text input field containing the URL: `https://a-c.tile.openstreetmap.org/{z}/{x}/{y}.png`. A 'Setup' button is located at the bottom right of the dialog box.

KAS-20 – AVL Key Feature Extras

◆ Scanned Maps

- Up to 20 scanned maps can be configured in the KAS-20.
 - Maximum size of these images must be 5120 px (horizontal) x 5120 px (vertical)
 - Maximum data size of 5 MB
 - The following formats can be used, jpg, jpeg, jpe, jfif, png, gif.

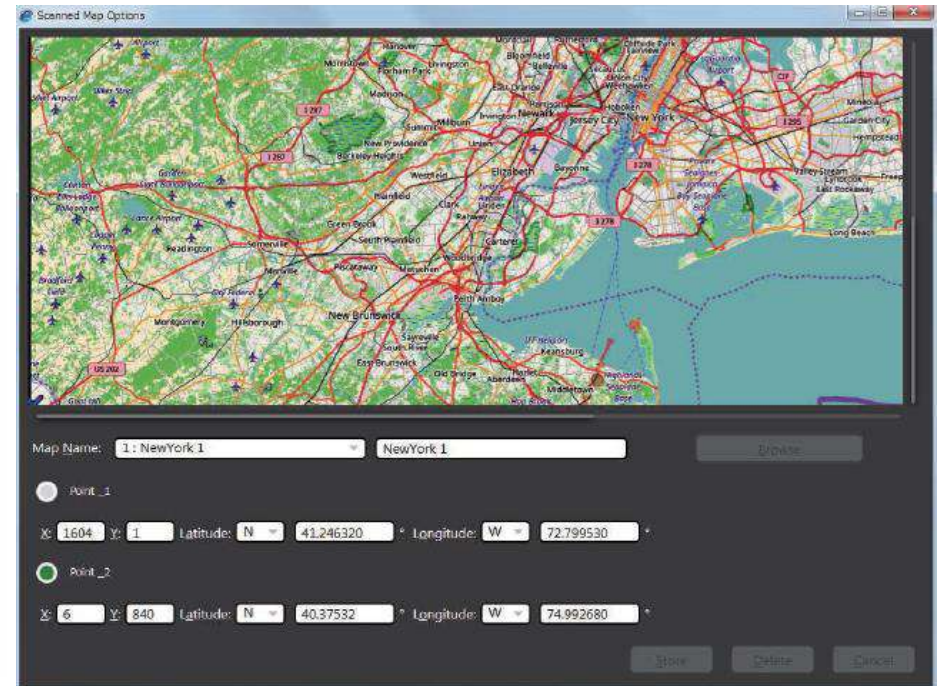
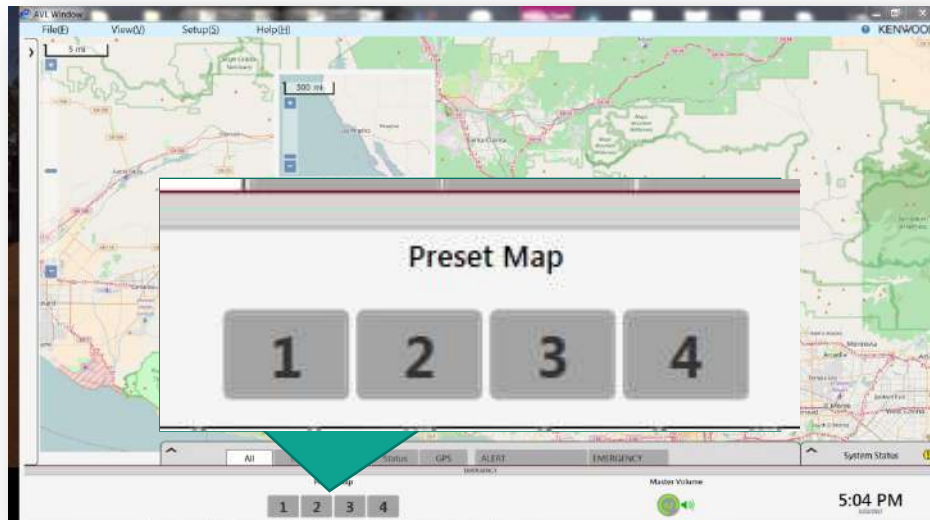

KAS-20 – AVL Key Features

◆ Geofence

- As with the KAS-10, a Geofence parameter can be created and configured in the new KAS-20.
 - Can detect and record entry or exit from the predefined area

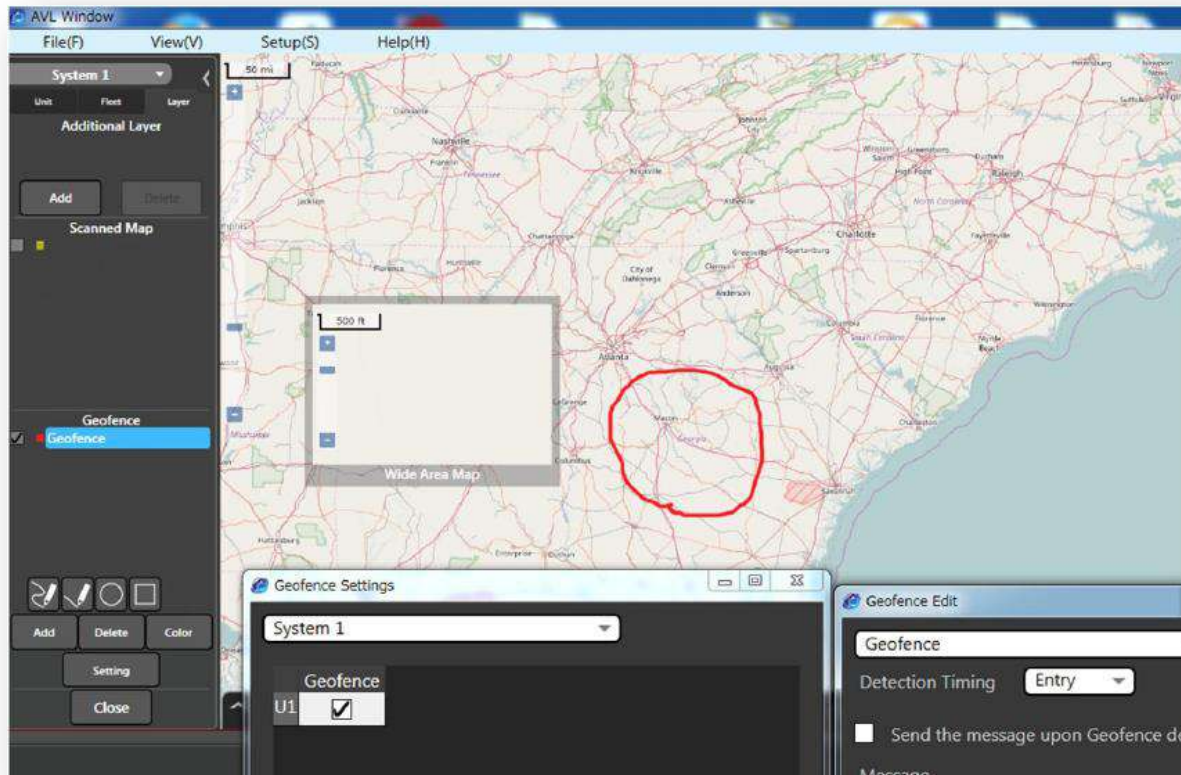

KAS-20 – AVL Key Features

◆ Lone Worker by Console

- Lone Worker is a function to check whether the user of a mobile station is in an emergency state due to an accident or due to injury in a desolate environment. The user must respond back to the base within a set time configured in the KAS-20
 - Lone Worker “Start and Stop” dialog box is used to begin the monitoring process.

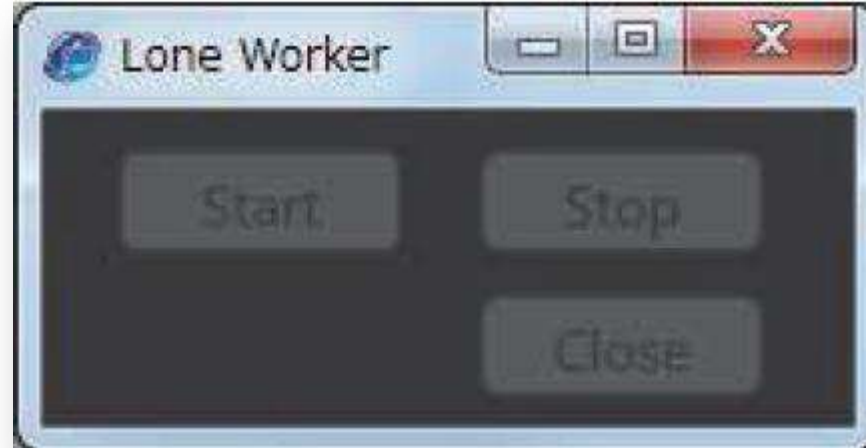

KAS-20 – AVL Key Features

◆ Polling by Console

- Auto Polling configuration of the KAS-20;
 - Two Auto Polling interval settings
 - This can be accomplished through the Auto Polling screen in the KAS-20. All parameters associated with auto polling can be found in this screen. See below.

The screenshot displays the 'Auto Polling' configuration screen in the KAS-20 interface. The 'Auto Polling' tab is highlighted in red. The screen is divided into several sections:

- Auto Polling:** A checkbox is checked.
- Day:** A grid of checkboxes for days of the week. Monday, Tuesday, Wednesday, Thursday, and Friday are checked. Saturday and Sunday are unchecked. Below this grid are three buttons: 'Everyday', 'Weekdays', and 'Weekend'.
- Time:** A radio button for 'All Day' is selected. Below it are radio buttons for 'Start/ Stop', 'Start Time', and 'Stop Time', each with a corresponding input field.
- Interval for Out of Range:** A checkbox is unchecked.
- Pause:** A checkbox for 'Pause (Power-off)' is unchecked. Below it is a 'Power-off Status' input field.
- Interval for Single Auto Polling:** A dropdown menu is set to '10' with '[sec]' next to it.
- Interval for Series of Auto Pollings:** A dropdown menu is set to '15' with '[min]' next to it.

KAS-20 – AVL Key Features

◆ Additional Request /Polling Options

- Similar to the KAS-10, the KAS-20 offers a shortcut to special features
 - Go to the AVL Window and right click on one of the mobile unit in the list
 - A pop-up window will display giving you other options available related to, tracking, polling, re-grouping, etc. See screen shot below.

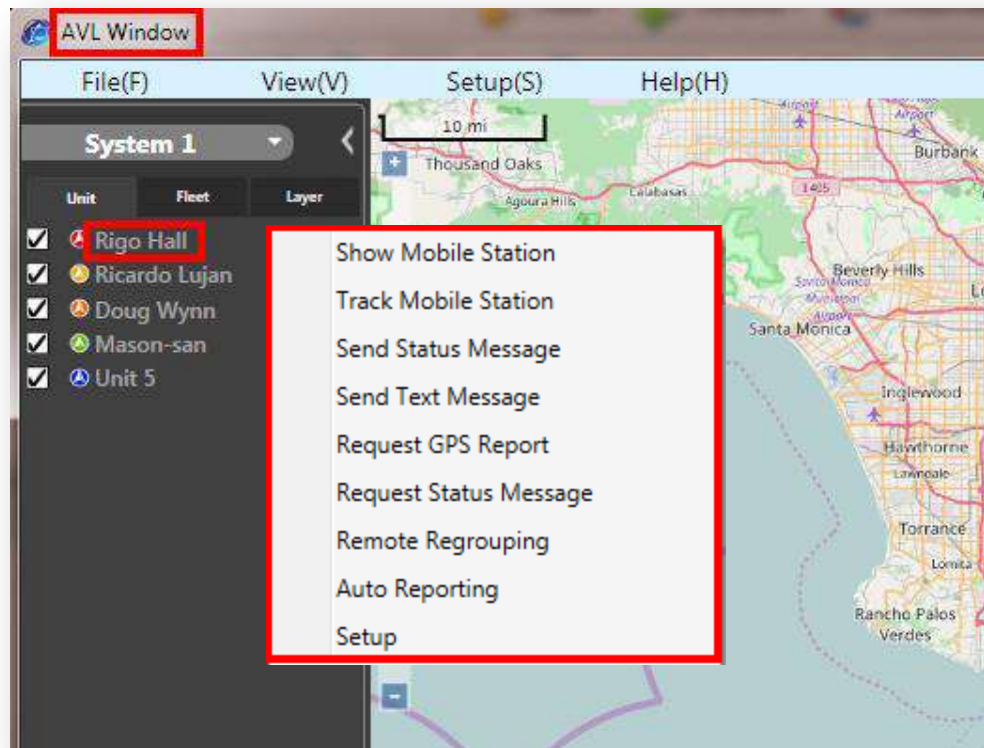

KAS-20 – AVL Key Features

◆ Fleet Base Display

- The KAS-20 will now allow the user to see what Fleet the mobile units, groups and consoles belong to. This can be found under the AVL Window display.

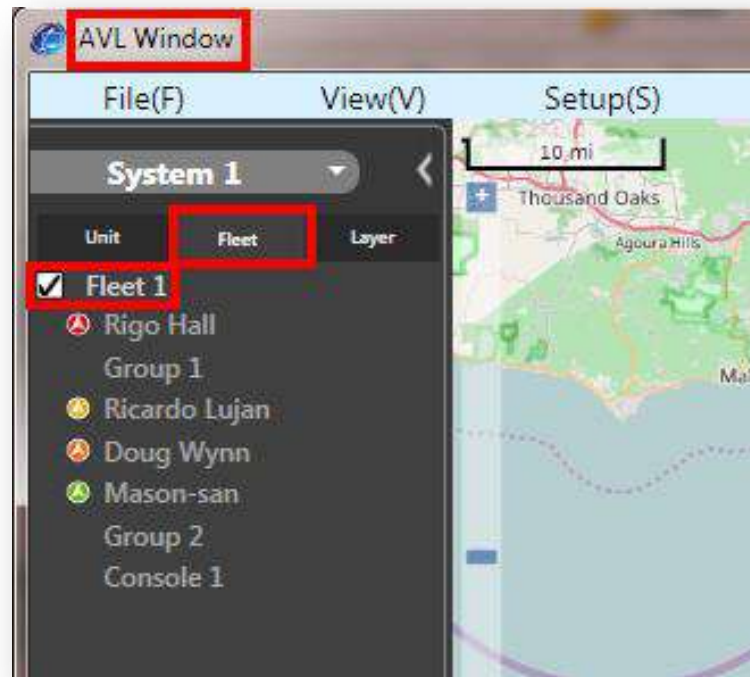

KAS-20 – AVL Key Features

◆ Emergency Alerts

- When an emergency occurs at a mobile station
 - An Emergency tone is emitted and the emergency bar at the bottom of the Dispatch Window lights up in red.
 - The **Emergency** tab in the **Log** pane is highlighted in red, and the notified emergencies are listed. Lines corresponding to emergency notifications that have not been processed are highlighted.
 - To call back a mobile station that initiated the emergency, select a log, right click on it and press the PTT button on the KAS-20



Date and Time	From	To	Type	Result	Activity	Elapsed Time
2016/11/30 17:02:19	NxTrunk-103		EMERGENCY	None	--- (Terminate emergency mode)	00:01
2016/11/30 17:01:58	NxTrunk-103		EMERGENCY	None	--- (Emergency Man down)	00:02
2016/11/30 17:01:38	NxTrunk-103		EMERGENCY	None	--- (Emergency)	00:02
2016/11/30 17:01:17	NxTrunk-103		EMERGENCY	None	--- (Lone Worker)	00:04
2016/11/30 17:00:57	NxTrunk-103		EMERGENCY	None	--- (Motion Detection)	00:04
2016/11/30 17:00:37	NxTrunk-103		EMERGENCY	None	--- (Stationary Detection)	00:04
2016/11/30 17:00:16	NxTrunk-103		EMERGENCY	None	--- (Terminate emergency mode)	00:05

KAS-20 – AVL Key Features

◆ GEN2 GPS

- KAS-20 will take advantage of the Gen2 features like enhanced GPS reporting
 - 750 counts Per 1 channel and 1 minute *
 - KAS-10 will not support Gen2 GPS features.

Each GPS radios has it's own time to transmit.
The System can manages the GPS traffic efficiently. So there is no collision.

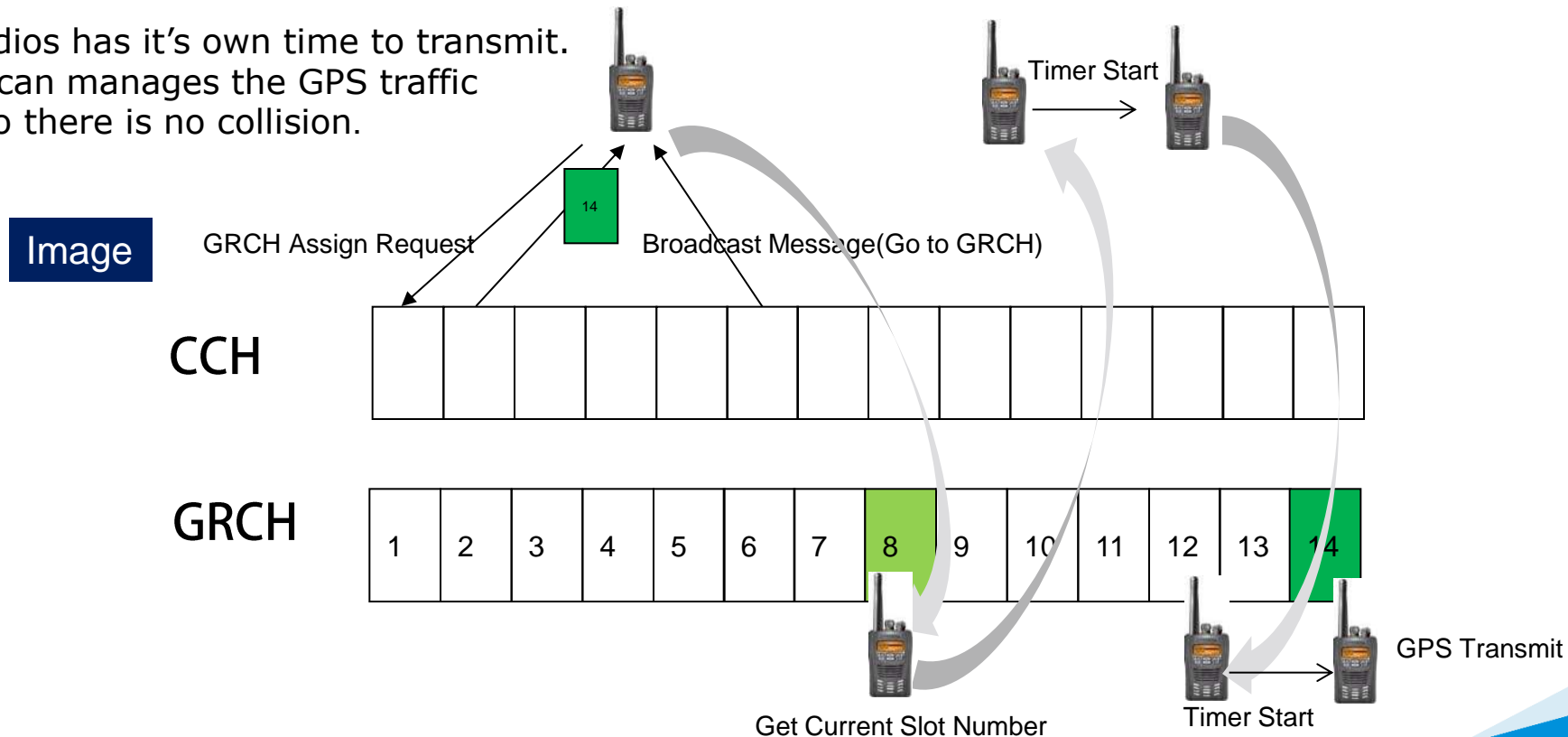

KAS-20 - Dispatch Key Feature

◆ Dispatch Key Feature

- ❑ AMBE+2 Software Vocoder
- ❑ Multiple Voice Encoding / Decoding (Up to 8) KWD code
- ❑ Voice Patching group
- ❑ Call Group Priority
- ❑ Text Messaging
- ❑ Voice Recording / Playback

The Dispatch Window is structured as follows.



KAS-20 - Dispatch Key Feature

◆ Dispatch Key Feature

▣ AMBE+2 Software Vocoder

- Using the DVSI AMBE +2 software allows for direct integration with the KAS-20 software and no need for the USB-3000 Dongle Vocoder
- Its Built in!

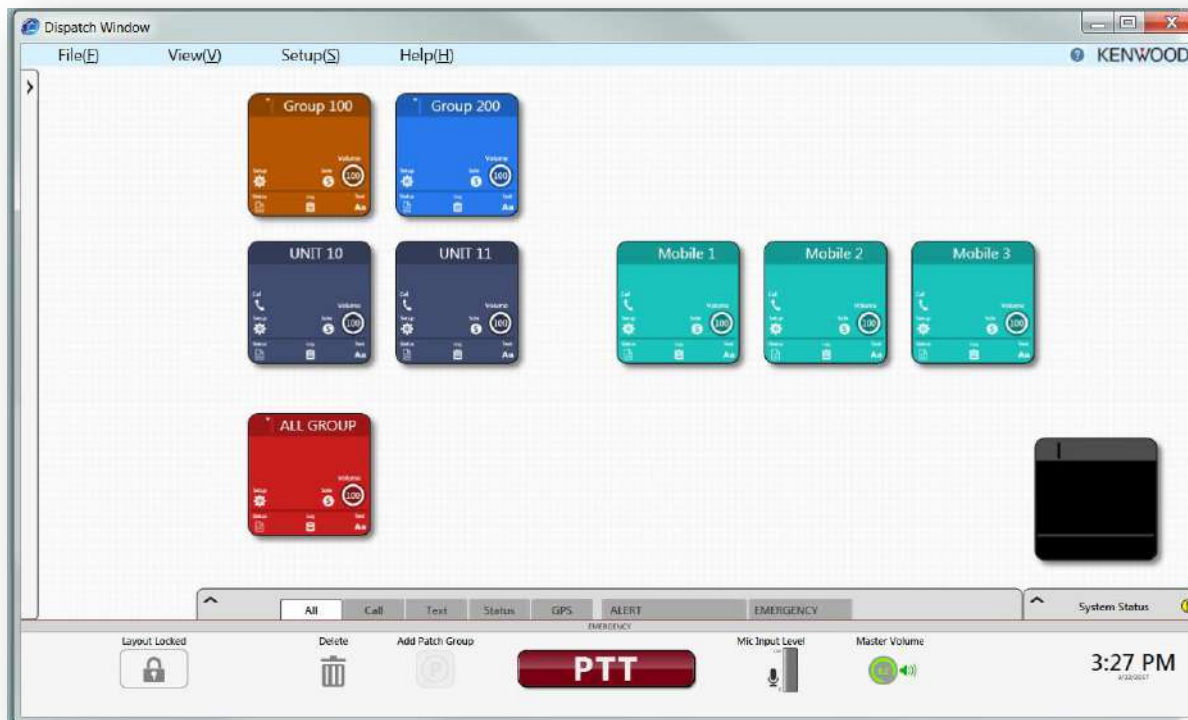

KAS-20 - Dispatch Key Feature

◆ Multiple Voice Encoding / Decoding

- Multiple Voice Encoding / Decoding (Up to 8) (KWD-20VP) Option License
- With the options you can communicate with multiple (Up to 8) channels at once

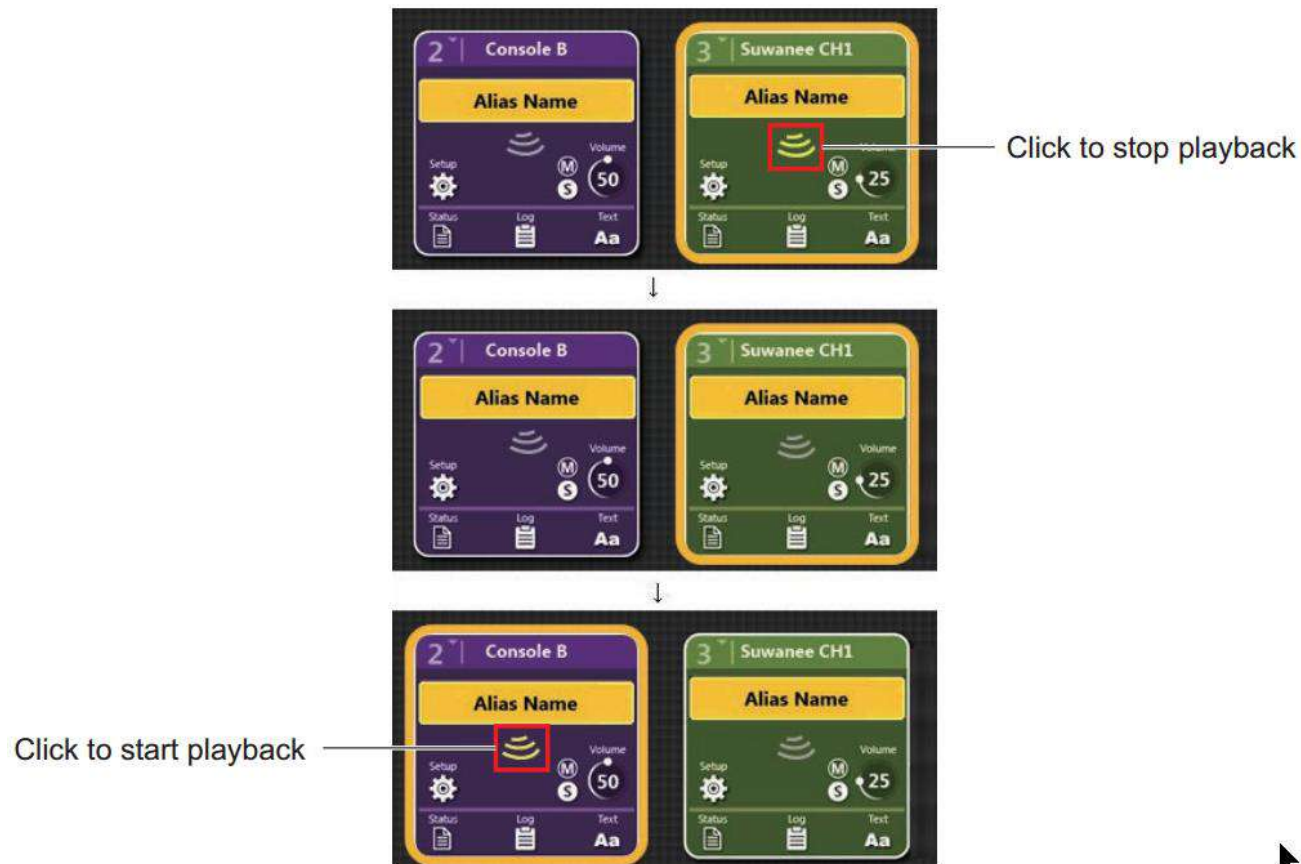

KAS-20 - Dispatch Key Feature

◆ Voice Patching group

- Similar to remote regrouping but more flexible
- You can drag and drop Groups into a temporary Pane
- When you are done you drag it to the trash 

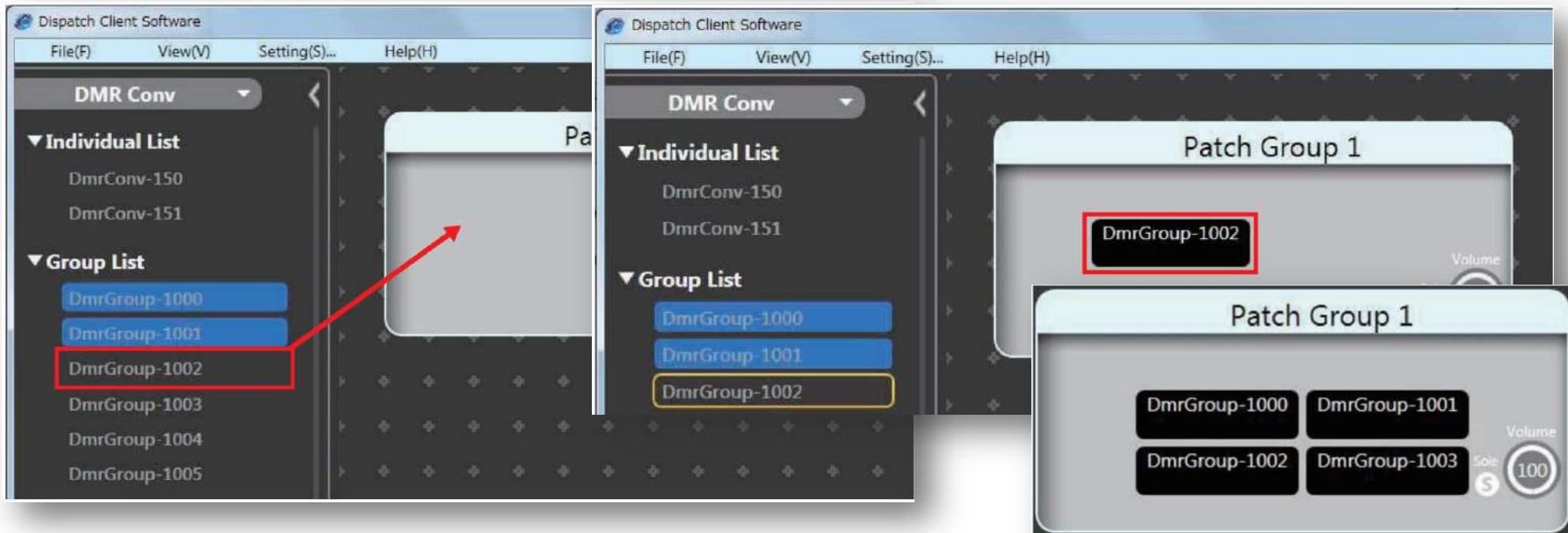

KAS-20 - Dispatch Key Feature

◆ Call Group Priority

- ▣ There are 10 Group Priorities from a Level of Off to 10

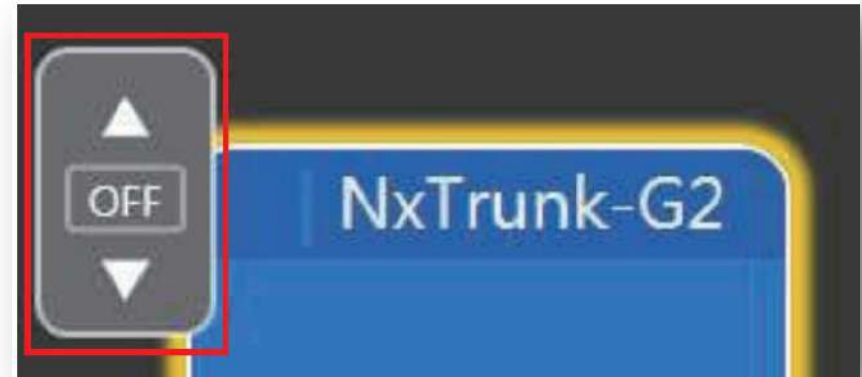

KAS-20 - Dispatch Key Feature

◆ Text Messaging

- Freeform Text Messaging or SMS messages can be generated from each Dispatch Box for Unit or a Group

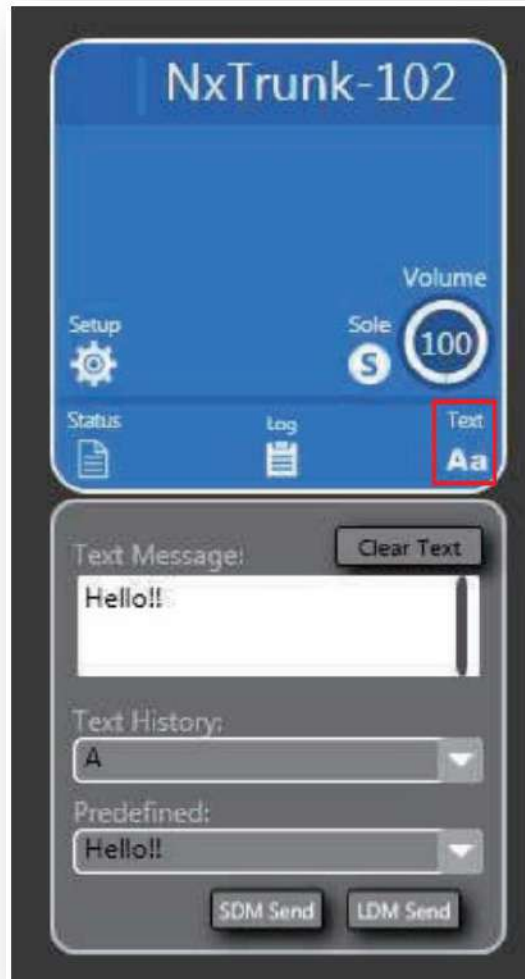

KAS-20 - Dispatch Key Feature

◆ Voice Recording / Playback

- ▣ Audio recording built-in, Converts to MP3 and can retain recording from 1 to 999 days (Option License required)

The screenshot displays a software interface with a call log table and a 'Play' dialog box. The call log table has columns for Date and Time, From, To, and Type. The 'Play' dialog box is open, showing a text field with the value '2016/11/30 14:53:40', playback controls (back, stop, play, forward), and 'MP3 Export' and 'Close' buttons. A context menu is open over the table, with 'Play' highlighted.

Date and Time	From	To	Type
2016/11/30 14:33:57	BASE-1	NxTrunk-G1	Call
2016/11/30 14:31:52	BASE-1	NxTrunk-G1	Call
2016/11/29 14:08:27	BASE-1	NxTrunk-G1	Call
2016/11/29 14:07:48	BASE-1	NxTrunk-G1	Call
2016/11/29 14:07:26	BASE-1	NxTrunk-G1	Call
2016/11/29 14:00:49	BASE-1	NxTrunk-G1	Call
2016/11/29 13:50:40	BASE-1	NxTrunk-G1	Call
2016/11/29 13:49:34	BASE-1	NxTrunk-G1	Call
2016/11/29 13:48:20	BASE-1	NxTrunk-G1	Call
2016/11/29 13:47:20	BASE-1	NxTrunk-G1	Call
2016/11/29 13:46:53	BASE-1	NxTrunk-G1	Call

KAS-20 - Licensing

◆ Licensing

▣ Client License KAS-20

- Voice Dispatch = KWD-20C-VD for Voice
- Location Management = KWD-20LM for AVL
- Voice Path = KWD-20C-VP for each Pathway to talk on (Vocoder)

▣ Server License

- Multi-Client = KWD-20S-MC for each computer you connect to.
- RF System = KWD-20S-RS for each system (Channel of RF) you want to connect to.
- Voice Recording = KWD-20S-VR for voice recording function

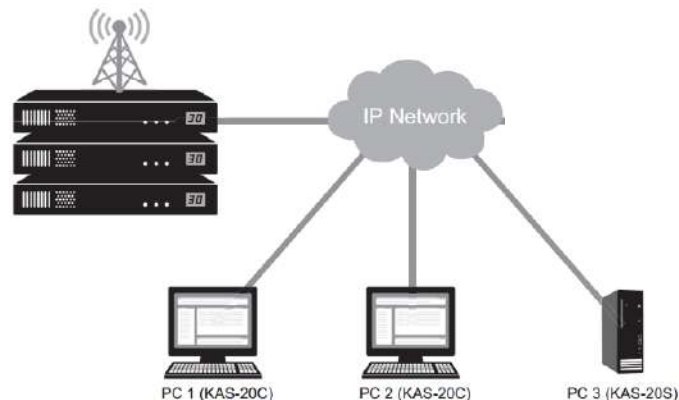

KAS-20 - Licensing

◆ Licensing

□ Option numbers

KWD-20C-LM	K	LOCATION MANAGEMENT LICENSE
KWD-20C-VD	K	VOICE DISPATCH LICENSE
KWD-20C-VP	K	VOICE PATH LICENSE
KWD-20S-MC	K	MULTI-CLIENT LICENSE
KWD-20S-RS	K	RF SYSTEM LICENSE
KWD-20S-VR	K	VOICE RECORD LICENSE

- **C** is for Clients / Computers
- **S** is for Server

JVCKENWOOD