



Software-Defined Radio, Redefined.

The Barrett 4050 HF SDR transceiver is the new centrepiece of the Barrett range of HF communications equipment. It combines Software-Defined Radio technology with the intuitive "ease of use" that has become synonymous with the Barrett name. When teamed with other Barrett HF products the versatile Barrett 4050 transceiver provides secure email, data transfer and telephone connectivity within an HF network and onwards to the international telephone network and internet.



The Barrett 4050 handset app supports iOS, Android and Windows devices for wireless voice and radio control.

- Advanced fully software-defined architecture
- Intuitive and user-friendly touch-screen interface
- IP Connectivity and remote control enabled
- Wireless operation via iOS, Android & Windows devices
- USB connection for transceiver programming and key fill
- Multi-Language menu
- Digital Voice and Secure Digital Voice
- On-board high speed data transmission waveforms
- Detachable wired and wireless control head connectivity
- Up to 150W transmit power
- Superior receiver performance
- Low current consumption
- 2G & 3G Automatic Link Establishment (ALE)
- *GPS Push* option
- Fully backwards compatible with existing radio networks

4050



Barrett 4050 HF SDR front panel

Software-Defined Architecture

The Barrett 4050's advanced Software-Defined architecture provides complete software control of RF modulation and bandwidths, providing unprecedented flexibility, reliability and ease of upgrade. Custom emissions and filter bandwidths of up to 16 kHz can be enabled with a simple software upgrade.

High Resolution Touch Screen Control

 Access to the most advanced intuitive HF Radio interface on the market via a super bright high definition 24-bit colour touchscreen providing maximum view ability under all lighting conditions.

IP Network Connectivity

 The Barrett 4050's Wi-Fi adapter makes integration with existing networks simple. For vehicle and remote installations, the Barrett 4050 wireless access point built into the 4050 control head allows mobile cellular handsets and tablets to connect directly to the transceiver. Advanced network configurations are supported by the optional Barrett 4050 Breakout Box (BoB) which provides Ethernet connectivity.

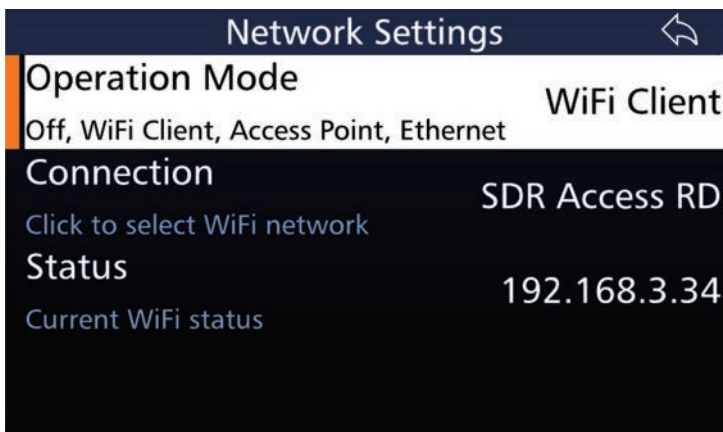

Multi-Language Menu

Change the Barrett 4050 language setting at the touch of a button. Each radio ships with multiple language menus including English, French, Spanish, Arabic, Russian, Turkish and Chinese.



Enhanced DSP Noise Reduction

 The new digital signal processor (DSP) provides clear intelligible voice communications on analogue circuits through the digital removal of background noise and interference. The standard DSP noise reduction system provides outstanding voice quality by reducing radio frequency interference, and the effects of electrical interference by enhancing audio signals to provide easier listening.

Secure Digital Voice

 The Barrett 4050's Secure Digital Voice option with automatically variable vocoder rates, offer two digital encryption standards. In non-export controlled DES 56 vocoder rates of 700, 1200 and 2400bps or in export controlled AES 256 vocoder rates of 600, 1200 and 2400bps, which delivers leading edge voice communication performance and security at all times.

Advanced Frequency Hopping (optional)



 The unique, easy to use Frequency Hopping* option requires no central synchronisation station, has no entry or late entry time delay and requires no handshaking. Available hopping rates of 5 or 25 hops per second, using a 8 digit hopping encryption key, with a user selectable hopping bandwidth to suit a variety of antenna types. The system provides excellent protection against electronic warfare (EW) attacks and can be operated for extended periods in the field without synchronisation.

Advanced Calling Features

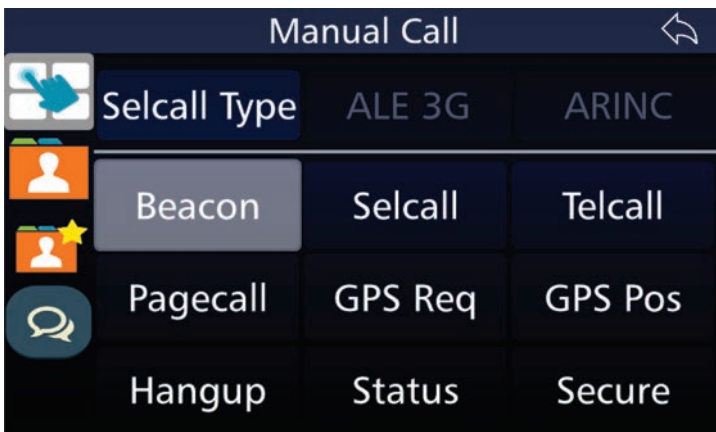
 The Barrett 4050 transceiver is fully interoperable with advanced digital selective calling systems commonly used by many peacekeeping and non-government organisations globally. The Barrett 4050 transceiver provides four and six digit selective call features, including telephone interconnect, SMS text, GPS tracking, status calling, point to point and/or multipoint secure call and remote transceiver disable capabilities.



Automatic Link Establishment

  Fully backwards compatible 2nd generation (2G) ALE based on MIL-STD-188-141B (JITC certified) and FED-STD-1045 is available optionally for automatic point to point and/or multipoint calling including telephone interconnect, AMD messaging text and GPS position, For superior fast link setup (FLSU), robust packet data and greater penetration on noisy channels, 3rd

generation (3G) ALE based on STANAG 4538 is optionally available.



Barrett 4050 HF SDR remote head configuration

Data Modems

Multiple data waveform options are provided for in the Barrett 4050 including MIL-STD-188-110A/B (STANAG 4285, 4415, 4481, 4529, 4539), CLOVER 2500 and the forthcoming CLOVER NG standard. Combined with Barrett's latest Digital Transmission software and intuitive user interface these waveforms provide unparalleled performance with "throughput" rates up to and in excess of 19200 bps.

Integrated GPS Interface

 Barrett's GPS interface supports connection of any NMEA 0183 external GPS receiver antenna for tracking applications. This interface provides emergency call features and position information on all deployed equivalently equipped HF assets. Combined with Barrett's soon to be released GPS Push tracking solution, Barrett can provide unrivalled asset tracking performance over HF.

Desktop, Mobile and Tablet Applications

 Control the Barrett 4050 transceiver from all major mobile and desktop platforms. The Barrett 4050 handset app supports iOS, Android and Windows devices for wireless voice and radio control. Full remote control is available via the Barrett 4050 Virtual Control Head app, providing unprecedented access to all transceiver functionality on Windows, iPad and Android tablets

*Subject to export controls



Barrett 4050 HF SDR rear panel

General Specifications

TX Frequency Range	1.6MHz – 30MHz
RX Frequency Range	250KHz – 30MHz
Channel Capacity	1000
Frequency Stability	±0.5 ppm (±0.3 ppm optional)
Frequency Resolution	1 Hz tunable receiver
Operating Modes	J3E (USB, LSB) - H2B (AM) - J2A (CW) - J2B (AFSK) Software-Defined filter bandwidth
Filter Bandwidths	Fully Software-Defined standard and custom filter range from 300Hz to 3000Hz and beyond.
Operating Temperature	-30° to +70°, relative humidity 95%, non condensing
Frequency Hopping	5 or 25 hops per second
Supply Voltage	+11V DC or 24V DC operation
Selcall System	Based on CCIR 493-4, 4 and 6 digit systems
ALE Standards	2G & 3G ALE
Current Consumption	350mA standby (muted)
Sensitivity	-121dBm (0.20 μV) for 10dB SINAD
RF Output Power	150W PEP (with 24V supply) 125W PEP (with 12V supply)
Duty Cycle	100% data with fan option
Standards	Designed to meet or exceed: <ul style="list-style-type: none"> - FCC – Part 87 - FCC – Part 90 - CE# - Australia/New Zealand AS/NZS 4770 2000 and AS/NZS 4582:1999 and AS 60529:2004 - EMC and vibration Standard IEC 945# - Designed to meet Mil-STD 810G for temperature, humidity, altitude, shock, vibration and IP54 - NTIA# - JITC#

Specifications are typical. Equipment descriptions and specifications are subject to change without notice or obligation. # Approval pending

Break Out Box (optional)

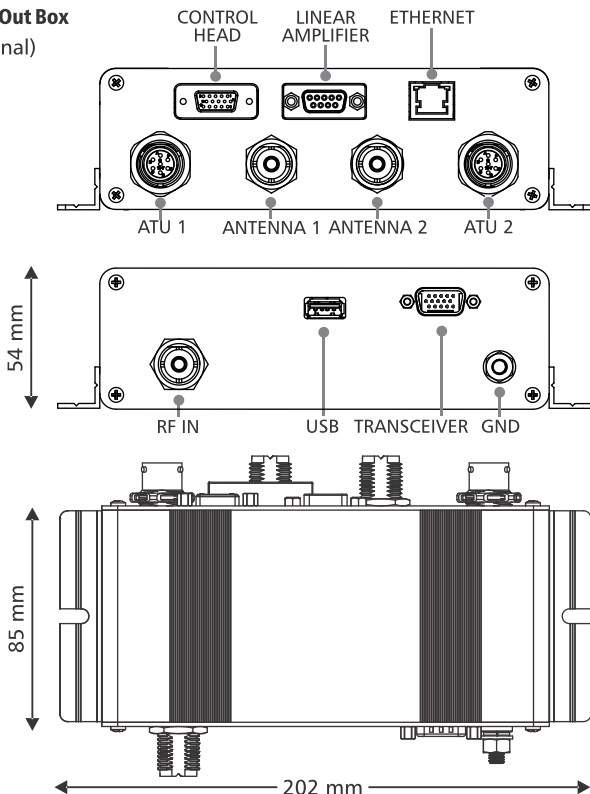

4050 remote control head
(trunk mount configuration)
Weight 0.35 kg

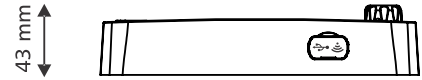
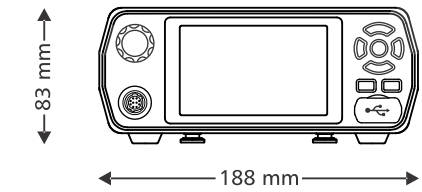

4050 remote control configuration
(trunk mount) main unit
Weight 2.2 kg

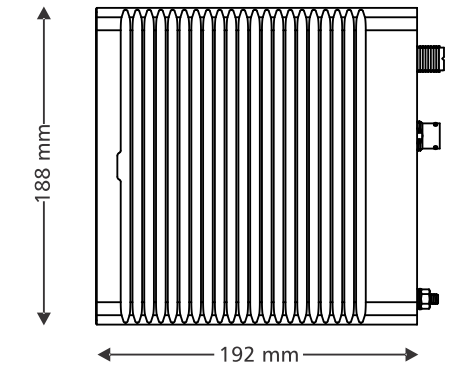

4050 local control configuration
Weight 2.55 kg

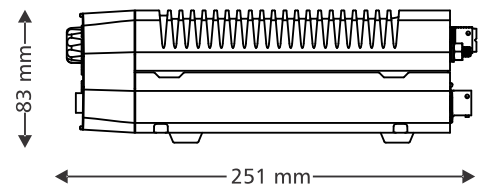
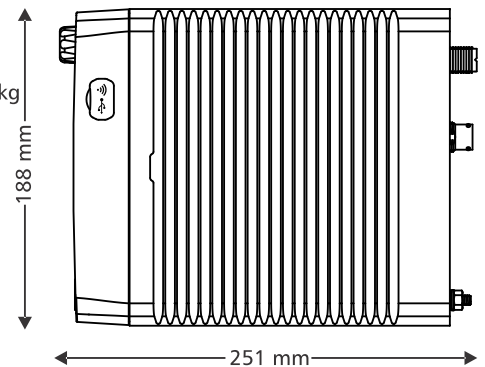

BCB40500/8

ISO 9001

BUREAU VERITAS
Certification



Head Office:

Barrett Communications Pty Ltd
47 Discovery Drive, Bibra Lake,
WA, 6163 AUSTRALIA
Tel: +61 8 9434 1700
Fax: +61 8 9418 6757
Email: information@barrettcommunications.com.au

www.barrettcommunications.com.au